

## JEE(MAIN) – 2016 TEST PAPER WITH SOLUTION (HELD ON SUNDAY 03<sup>th</sup> APRIL, 2016)

### PART A – MATHEMATICS

1. A value of  $\theta$  for which  $\frac{2+3i\sin\theta}{1-2i\sin\theta}$  is purely imaginary, is :

- (1)  $\sin^{-1}\left(\frac{1}{\sqrt{3}}\right)$       (2)  $\frac{\pi}{3}$   
 (3)  $\frac{\pi}{6}$       (4)  $\sin^{-1}\left(\frac{\sqrt{3}}{4}\right)$

**Ans. (1)**

**Sol.**  $Z = \frac{2+3i\sin\theta}{1-2i\sin\theta}$

$$\Rightarrow Z = \frac{(2+3i\sin\theta)(1+2i\sin\theta)}{1+4\sin^2\theta}$$

$$= \frac{(2-6\sin^2\theta)+7i\sin\theta}{1+4\sin^2\theta}$$

for purely imaginary  $Z$ ,  $\text{Re}(Z) = 0$

$$\Rightarrow 2 - 6\sin^2\theta = 0 \Rightarrow \sin\theta = \pm \frac{1}{\sqrt{3}}$$

$$\Rightarrow \theta = \pm \sin^{-1}\left(\frac{1}{\sqrt{3}}\right)$$

2. The system of linear equations

$$x + \lambda y - z = 0$$

$$\lambda x - y - z = 0$$

$$x + y - \lambda z = 0$$

has a non-trivial solution for :

- (1) exactly three values of  $\lambda$ .  
 (2) infinitely many values of  $\lambda$ .  
 (3) exactly one value of  $\lambda$ .  
 (4) exactly two values of  $\lambda$ .

**Ans. (1)**

**Sol.**  $\begin{vmatrix} 1 & \lambda & -1 \\ \lambda & -1 & -1 \\ 1 & 1 & -\lambda \end{vmatrix} = 0 \Rightarrow \lambda = 0, 1, -1$

3. A wire of length 2 units is cut into two parts which are bent respectively to form a square of side =  $x$  units and a circle of radius =  $r$  units. If the sum of the areas of the square and the circle so formed is minimum, then :

- (1)  $2x = r$   
 (2)  $2x = (\pi + 4)r$   
 (3)  $(4 - \pi)x = \pi r$   
 (4)  $x = 2r$

**Ans. (4)**

**Sol.**

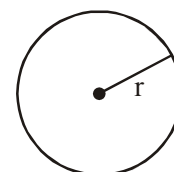
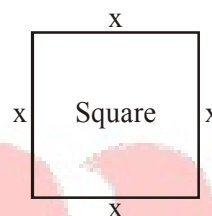

given that  $4x + 2\pi r = 2$

i.e.  $2x + \pi r = 1$

$$\therefore r = \frac{1-2x}{\pi} \quad \dots (i)$$

Area  $A = x^2 + \pi r^2$

$$= x^2 + \frac{1}{\pi}(2x-1)^2$$

for min value of area  $A$

$$\frac{dA}{dx} = 0 \text{ gives } x = \frac{2}{\pi+4} \quad \dots (ii)$$

from (i) & (ii)

$$r = \frac{1}{\pi+4} \quad \dots (iii)$$

$$\therefore x = 2r$$

4. A man is walking towards a vertical pillar in a straight path, at a uniform speed. At a certain point A on the path, he observes that the angle of elevation of the top of the pillar is  $30^\circ$ . After walking for 10 minutes from A in the same direction, at a point B, he observes that the angle of elevation of the top of the pillar is  $60^\circ$ . Then the time taken (in minutes) by him, from B to reach the pillar, is :
- (1) 5      (2) 6      (3) 10      (4) 20

Ans. (1)

Sol.

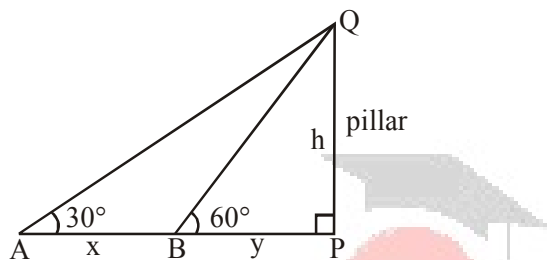

$$\Delta QPA : \frac{h}{x+y} = \tan 30^\circ \Rightarrow \sqrt{3} h = x + y \dots (i)$$

$$\Delta QPB : \frac{h}{y} = \tan 60^\circ \Rightarrow h = \sqrt{3} y \dots (ii)$$

$$\text{By (i) and (ii) : } 3y = x + y \Rightarrow y = \frac{x}{2}$$

$\therefore$  speed is uniform

Distance x in 10 mins

$$\Rightarrow \text{Distance } \frac{x}{2} \text{ in 5 mins}$$

5. Let two fair six-faced dice A and B be thrown simultaneously. If  $E_1$  is the event that die A shows up four,  $E_2$  is the event that die B shows up two and  $E_3$  is the event that the sum of numbers on both dice is odd, then which of the following statements is **NOT true** ?
- (1)  $E_1, E_2$  and  $E_3$  are independent.  
 (2)  $E_1$  and  $E_2$  are independent.  
 (3)  $E_2$  and  $E_3$  are independent.  
 (4)  $E_1$  and  $E_3$  are independent.

Ans. (1)

Sol.  $E_1 \rightarrow$  A shows up 4

$E_2 \rightarrow$  B shows up 2

$E_3 \rightarrow$  Sum is odd (i.e. even + odd or odd + even)

$$P(E_1) = \frac{6}{6.6} = \frac{1}{6}$$

$$P(E_2) = \frac{6}{6.6} = \frac{1}{6}$$

$$P(E_3) = \frac{3 \times 3 \times 2}{6.6} = \frac{1}{2}$$

$$P(E_1 \cap E_2) = \frac{1}{6.6} = P(E_1) \cdot P(E_2)$$

$\Rightarrow E_1$  &  $E_2$  are independent

$$P(E_1 \cap E_3) = \frac{1.3}{6.6} = P(E_1) \cdot P(E_3)$$

$\Rightarrow E_1$  &  $E_3$  are independent

$$P(E_2 \cap E_3) = \frac{1.3}{6.6} = \frac{1}{12} = P(E_2) \cdot P(E_3)$$

$\Rightarrow E_2$  &  $E_3$  are independent

$P(E_1 \cap E_2 \cap E_3) = 0$  ie impossible event.

6. If the standard deviation of the numbers 2, 3, a and 11 is 3.5, then which of the following is true ?

(1)  $3a^2 - 23a + 44 = 0$

(2)  $3a^2 - 26a + 55 = 0$

(3)  $3a^2 - 32a + 84 = 0$

(4)  $3a^2 - 34a + 91 = 0$

Ans. (3)

Sol.  $\therefore \text{S.D.} = \sqrt{\frac{\sum x_i^2}{n} - \left(\frac{\sum x_i}{n}\right)^2}$

$$\therefore \frac{49}{4} = \frac{4+9+a^2+121}{4} - \left(\frac{16+a}{4}\right)^2$$

$$\Rightarrow 3a^2 - 32a + 84 = 0$$

7. For  $x \in \mathbb{R}$ ,  $f(x) = |\log 2 - \sin x|$  and  $g(x) = f(f(x))$ , then :

(1) g is differentiable at  $x = 0$  and  $g'(0) = -\sin(\log 2)$

(2) g is not differentiable at  $x = 0$

(3)  $g'(0) = \cos(\log 2)$

(4)  $g'(0) = -\cos(\log 2)$

Ans. (3)

Sol. In the neighbourhood of  $x = 0$ ,  $f(x) = \log 2 - \sin x$

$$\therefore g(x) = f(f(x)) = \log 2 - \sin(f(x))$$

$$= \log 2 - \sin(\log 2 - \sin x)$$

It is differentiable at  $x = 0$ , so

$$\therefore g'(x) = -\cos(\log 2 - \sin x) (-\cos x)$$

$$\therefore g'(0) = \cos(\log 2)$$

8. The distance of the point (1, -5, 9) from the plane  $x - y + z = 5$  measured along the line  $x = y = z$  is :

- (1)  $\frac{20}{3}$     (2)  $3\sqrt{10}$     (3)  $10\sqrt{3}$     (4)  $\frac{10}{\sqrt{3}}$

Ans. (3)

Sol. Equation of line parallel to  $x = y = z$  through

(1, -5, 9) is  $\frac{x-1}{1} = \frac{y+5}{1} = \frac{z-9}{1} = \lambda$

If  $P(\lambda + 1, \lambda - 5, \lambda + 9)$  be point of intesection of line and plane.

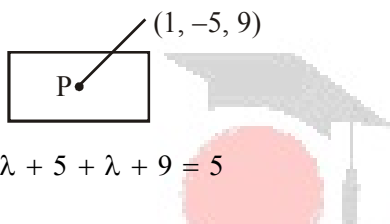

$\Rightarrow \lambda + 1 - \lambda + 5 + \lambda + 9 = 5$   
 $\Rightarrow \lambda = -10$   
 $\Rightarrow$  Coordinates point are  $(-9, -15, -1)$   
 $\Rightarrow$  Required distance =  $10\sqrt{3}$

9. The eccentricity of the hyperbola whose length of the latus rectum is equal to 8 and the length of its conjugate axis is equal to half of the distance between its foci, is :

- (1)  $\sqrt{3}$     (2)  $\frac{4}{3}$     (3)  $\frac{4}{\sqrt{3}}$     (4)  $\frac{2}{\sqrt{3}}$

Ans. (4)

Sol. Given

$\frac{2b^2}{a} = 8$  .... (1)

$2b = ae$  .... (2)

we know

$b^2 = a^2(e^2 - 1)$  .... (3)

substitute  $\frac{b}{a} = \frac{e}{2}$  from (2) in (3)

$\Rightarrow \frac{e^2}{4} = e^2 - 1$

$\Rightarrow 4 = 3e^2$

$\Rightarrow e = \frac{2}{\sqrt{3}}$

10. Let P be the point on the parabola,  $y^2 = 8x$  which is at a minimum distance from the cente C of the circle,  $x^2 + (y + 6)^2 = 1$ . Then the equation of the circle, passing through C and having its centre at P is :

(1)  $x^2 + y^2 - 4x + 9y + 18 = 0$

(2)  $x^2 + y^2 - 4x + 8y + 12 = 0$

(3)  $x^2 + y^2 - x + 4y - 12 = 0$

(4)  $x^2 + y^2 - \frac{x}{4} + 2y - 24 = 0$

Ans. (2)

Sol. Circle and parabola are as shown :

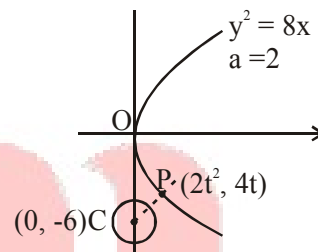

Minimum distance occurs along common normal.

Let normal to parabola be

$y + tx = 2.2.t + 2t^3$

pass through (0, -6) :

$-6 = 4t + 2t^3 \Rightarrow t^3 + 2t + 3 = 0$

$\Rightarrow t = -1$  (only real value)

$\therefore P(2, -4)$

$\therefore CP = \sqrt{4+4} = 2\sqrt{2}$

$\therefore$  equation of circle

$(x - 2)^2 + (y + 4)^2 = (2\sqrt{2})^2$

$\Rightarrow x^2 + y^2 - 4x + 8y + 12 = 0$

11. If  $A = \begin{bmatrix} 5a & -b \\ 3 & 2 \end{bmatrix}$  and  $A \text{ adj } A = A A^T$ , then  $5a + b$  is equal to :  
 (1) 13      (2) -1      (3) 5      (4) 4

Ans. (3)

Sol.  $A = \begin{bmatrix} 5a & -b \\ 3 & 2 \end{bmatrix}$  and  $A^T = \begin{bmatrix} 5a & 3 \\ -b & 2 \end{bmatrix}$

$$AA^T = \begin{bmatrix} 25a^2 + b^2 & 15a - 2b \\ 15a - 2b & 13 \end{bmatrix}$$

Now,  $A \text{ adj } A = |A|I_2 = \begin{bmatrix} 10a + 3b & 0 \\ 0 & 10a + 3b \end{bmatrix}$

Given  $AA^T = A \text{ adj } A$

$$15a - 2b = 0 \quad \dots(1)$$

$$10a + 3b = 13 \quad \dots(2)$$

Solving we get

$$5a = 2 \text{ and } b = 3$$

$$\therefore 5a + b = 5$$

12. Consider  $f(x) = \tan^{-1} \left( \sqrt{\frac{1 + \sin x}{1 - \sin x}} \right)$ ,  $x \in \left( 0, \frac{\pi}{2} \right)$ .

A normal to  $y = f(x)$  at  $x = \frac{\pi}{6}$  also passes through the point :

(1)  $\left( \frac{\pi}{4}, 0 \right)$       (2)  $(0, 0)$

(3)  $\left( 0, \frac{2\pi}{3} \right)$       (4)  $\left( \frac{\pi}{6}, 0 \right)$

Ans. (3)

Sol.  $f(x) = \tan^{-1} \left( \sqrt{\frac{1 + \sin x}{1 - \sin x}} \right)$  where  $x \in \left( 0, \frac{\pi}{2} \right)$

$$= \tan^{-1} \left( \sqrt{\frac{(1 + \sin x)^2}{1 - \sin^2 x}} \right)$$

$$= \tan^{-1} \left( \frac{1 + \sin x}{|\cos x|} \right)$$

$$= \tan^{-1} \left( \frac{1 + \sin x}{\cos x} \right) \quad \left( \text{as } x \in \left( 0, \frac{\pi}{2} \right) \right)$$

$$= \tan^{-1} \left( \frac{\left( \cos \frac{x}{2} + \sin \frac{x}{2} \right)^2}{\cos^2 \frac{x}{2} - \sin^2 \frac{x}{2}} \right)$$

$$= \tan^{-1} \left( \tan \left( \frac{\pi}{4} + \frac{x}{2} \right) \right)$$

$$f(x) = \frac{\pi}{4} + \frac{x}{2} \quad \text{as } x \in \left( 0, \frac{\pi}{2} \right) \Rightarrow f' \left( \frac{\pi}{6} \right) = \frac{1}{2}$$

$\therefore$  Equation of normal

$$\left( y - \frac{\pi}{3} \right) = -2 \left( x - \frac{\pi}{6} \right)$$

which passes through  $\left( 0, \frac{2\pi}{3} \right)$

13. Two sides of a rhombus are along the lines,  $x - y + 1 = 0$  and  $7x - y - 5 = 0$ . If its diagonals intersect at  $(-1, -2)$ , then which one of the following is a vertex of this rhombus ?

(1)  $\left( -\frac{10}{3}, -\frac{7}{3} \right)$       (2)  $(-3, -9)$

(3)  $(-3, -8)$       (4)  $\left( \frac{1}{3}, -\frac{8}{3} \right)$

Ans. (4)

Sol. Equation of angle bisector of the lines  $x - y + 1 = 0$  and  $7x - y - 5 = 0$  is given by

$$\frac{x - y + 1}{\sqrt{2}} = \pm \frac{7x - y - 5}{5\sqrt{2}}$$

$$\Rightarrow 5(x - y + 1) = 7x - y - 5$$

and

$$5(x - y + 1) = -7x + y + 5$$

$$\therefore 2x + 4y - 10 = 0 \Rightarrow x + 2y - 5 = 0 \text{ and}$$

$$12x - 6y = 0 \Rightarrow 2x - y = 0$$

Now equation of diagonals are

$$(x + 1) + 2(y + 2) = 0 \Rightarrow x + 2y + 5 = 0 \quad \dots(1)$$

and

$$2(x + 1) - (y + 2) = 0 \Rightarrow 2x - y = 0 \quad \dots(2)$$

Clearly  $\left( \frac{1}{3}, -\frac{8}{3} \right)$  lies on (1)

14. If a curve  $y = f(x)$  passes through the point  $(1, -1)$  and satisfies the differential equation,  $y(1 + xy) dx = x dy$ ,

then  $f\left(-\frac{1}{2}\right)$  is equal to :

- (1)  $\frac{4}{5}$       (2)  $-\frac{2}{5}$       (3)  $-\frac{4}{5}$       (4)  $\frac{2}{5}$

Ans. (1)

Sol. Given differential equation

$$y dx + xy^2 dx = x dy$$

$$\Rightarrow \frac{x dy - y dx}{y^2} = x dx$$

$$\Rightarrow -d\left(\frac{x}{y}\right) = d\left(\frac{x^2}{2}\right)$$

Integrating we get

$$-\frac{x}{y} = \frac{x^2}{2} + C$$

$\therefore$  It passes through  $(1, -1)$

$$\therefore 1 = \frac{1}{2} + C \Rightarrow C = \frac{1}{2}$$

$$\therefore x^2 + 1 + \frac{2x}{y} = 0 \Rightarrow y = \frac{-2x}{x^2 + 1}$$

$$\therefore f\left(-\frac{1}{2}\right) = \frac{4}{5}$$

15. If all the words (with or without meaning) having five letters, formed using the letters of the word SMALL and arranged as in a dictionary; then the position of the word SMALL is :

- (1) 58<sup>th</sup>      (2) 46<sup>th</sup>      (3) 59<sup>th</sup>      (4) 52<sup>nd</sup>

Ans. (1)

Sol. Total number of words which can be formed using all the letters of the word 'SMALL'

$$= \frac{5!}{2!} = 60$$

Now, 60<sup>th</sup> word is  $\rightarrow$  SMLLA

59<sup>th</sup> word is  $\rightarrow$  SMLAL

58<sup>th</sup> word is  $\rightarrow$  SMALL

16. If the 2<sup>nd</sup>, 5<sup>th</sup> and 9<sup>th</sup> terms of a non-constant A.P. are in G.P., then the common ratio of this G.P. is :-

- (1)  $\frac{7}{4}$       (2)  $\frac{8}{5}$       (3)  $\frac{4}{3}$       (4) 1

Ans. (3)

Sol. Let 'a' be the first term and d be the common difference

2<sup>nd</sup> term =  $a + d$ , 5<sup>th</sup> term =  $a + 4d$ ,

9<sup>th</sup> term =  $a + 8d$

$$\therefore \text{Common ratio} = \frac{a+4d}{a+d} = \frac{a+8d}{a+4d} = \frac{4d}{3d} = \frac{4}{3}$$

17. If the number of terms in the expansion of

$$\left(1 - \frac{2}{x} + \frac{4}{x^2}\right)^n, x \neq 0, \text{ is } 28, \text{ then the sum of the}$$

coefficients of all the terms in this expansion, is :-

- (1) 729      (2) 64      (3) 2187      (4) 243

Ans. (1 or Bonus)

Sol. Number of terms in the expansion of

$$\left(1 - \frac{2}{x} + \frac{4}{x^2}\right)^n \text{ is } {}^{n+2}C_2 \text{ (considering } \frac{1}{x} \text{ and } \frac{1}{x^2} \text{ distinct)}$$

$$\therefore {}^{n+2}C_2 = 28 \Rightarrow n = 6$$

$$\therefore \text{Sum of coefficients} = (1 - 2 + 4)^6 = 729$$

But number of dissimilar terms actually will be

$2n + 1$  (as  $\frac{1}{x}$  and  $\frac{1}{x^2}$  are functions as same variable)

Hence it contains error, so a bonus can be expected.

18. If the sum of the first ten terms of the series

$$\left(1\frac{3}{5}\right)^2 + \left(2\frac{2}{5}\right)^2 + \left(3\frac{1}{5}\right)^2 + 4^2 + \left(4\frac{4}{5}\right)^2 + \dots \text{ is } \frac{16}{5}m,$$

then m is equal to :-

- (1) 99      (2) 102  
(3) 101      (4) 100

Ans. (3)

Sol. Given series is

$$S = \frac{8^2}{5^2} + \frac{12^2}{5^2} + \frac{16^2}{5^2} + \dots 10 \text{ terms}$$

$$= \frac{4^2}{5^2} (2^2 + 3^2 + 4^2 + \dots 10 \text{ terms})$$

$$= \frac{16}{25} \left( \frac{11 \cdot 12 \cdot 23}{6} - 1 \right) = \frac{16}{25} \times 505$$

$$\therefore m = 101$$

19. If the line,  $\frac{x-3}{2} = \frac{y+2}{-1} = \frac{z+4}{3}$  lies in the plane,  $lx + my - z = 9$ , then  $l^2 + m^2$  is equal to :-  
 (1) 2      (2) 26      (3) 18      (4) 5

Ans. (1)

Sol. Given line

$$\frac{x-3}{2} = \frac{y+2}{-1} = \frac{z+4}{3}$$

and Given plane is  $lx + my - z = 9$

Now, it is given that line lies on plane

$$\therefore 2l - m - 3 = 0 \Rightarrow 2l - m = 3 \quad \dots(1)$$

Also,  $(3, -2, -4)$  lies on plane

$$3l - 2m = 5 \quad \dots(2)$$

Solving (1) and (2), we get

$$l = 1, m = -1$$

$$\therefore l^2 + m^2 = 2$$

20. The Boolean Expression  $(p \wedge \sim q) \vee q \vee (\sim p \wedge q)$  is equivalent to :-  
 (1)  $p \vee \sim q$     (2)  $\sim p \wedge q$     (3)  $p \wedge q$     (4)  $p \vee q$

Ans. (4)

Sol. Given boolean expression is

$$(p \wedge \sim q) \vee q \vee (\sim p \wedge q)$$

$$(p \wedge \sim q) \vee q = (p \vee q) \wedge (\sim q \vee q) = (p \vee q) \wedge t = (p \vee q)$$

Now,

$$(p \vee q) \vee (\sim p \wedge q) = p \vee q$$

21. The integral  $\int \frac{2x^{12} + 5x^9}{(x^5 + x^3 + 1)^3} dx$  is equal to :-

(1)  $\frac{-x^{10}}{2(x^5 + x^3 + 1)^2} + C$       (2)  $\frac{-x^5}{(x^5 + x^3 + 1)^2} + C$

(3)  $\frac{x^{10}}{2(x^5 + x^3 + 1)^2} + C$       (4)  $\frac{x^5}{2(x^5 + x^3 + 1)^2} + C$

where C is an arbitrary constant.

Ans. (3)

Sol.  $\div$  by  $x^{15}$  in  $N^r$  &  $D^r$

$$\int \frac{\left(\frac{2}{x^3} + \frac{5}{x^6}\right) dx}{\left(1 + \frac{1}{x^2} + \frac{1}{x^5}\right)^3}$$

$$\text{Let } 1 + \frac{1}{x^2} + \frac{1}{x^5} = t \Rightarrow dt = -\left(\frac{2}{x^3} + \frac{5}{x^6}\right) dx$$

$$\int \frac{-dt}{t^3} = \frac{1}{2t^2} + c$$

22. If one of the diameters of the circle, given by the equation,  $x^2 + y^2 - 4x + 6y - 12 = 0$ , is a chord of a circle S, whose centre is at  $(-3, 2)$ , then the radius of S is :-

- (1) 10      (2)  $5\sqrt{2}$       (3)  $5\sqrt{3}$       (4) 5

Ans. (3)

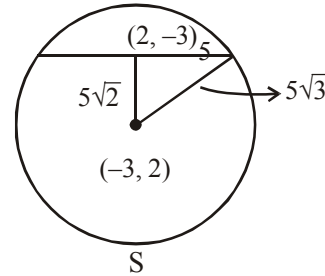

Sol.

23.  $\lim_{n \rightarrow \infty} \left( \frac{(n+1)(n+2)\dots 3n}{n^{2n}} \right)^{1/n}$  is equal to :-

(1)  $3 \log 3 - 2$       (2)  $\frac{18}{e^4}$

(3)  $\frac{27}{e^2}$       (4)  $\frac{9}{e^2}$

Ans. (3)

Sol.  $e^{\lim_{n \rightarrow \infty} \frac{1}{n} \sum_{r=1}^{2n} \ln\left(1 + \frac{r}{n}\right)} = e^{\int_0^2 \ln(1+x) dx}$

$$\Rightarrow e^{((x+1)\{\ln(x+1)-1\})_0^2} = e^{3\ln 3 - 2} = \frac{27}{e^2}$$

24. The centres of those circles which touch the circle,  $x^2 + y^2 - 8x - 8y - 4 = 0$ , externally and also touch the x-axis, lie on :-

- (1) A parabola  
 (2) A circle  
 (3) An ellipse which is not a circle  
 (4) A hyperbola

Ans. (1)

Sol. Consider line L at a dist. of 6 unit below x axis

$$\Rightarrow PC = PQ$$

$$\Rightarrow P \text{ lies on a parabola}$$

for which C is focus

and L is directrix

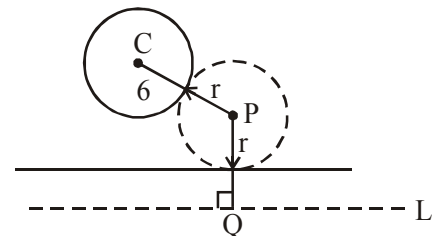

25. Let  $\vec{a}, \vec{b}$  and  $\vec{c}$  be three unit vectors such that  $\vec{a} \times (\vec{b} \times \vec{c}) = \frac{\sqrt{3}}{2}(\vec{b} + \vec{c})$ . If  $\vec{b}$  is not parallel to  $\vec{c}$ , then the angle between  $\vec{a}$  and  $\vec{b}$  is :-  
 (1)  $\frac{5\pi}{6}$       (2)  $\frac{3\pi}{4}$       (3)  $\frac{\pi}{2}$       (4)  $\frac{2\pi}{3}$

Ans. (1)

Sol.  $(\vec{a} \cdot \vec{c} - \frac{\sqrt{3}}{2})\vec{b} - (\vec{a} \cdot \vec{b} + \frac{\sqrt{3}}{2})\vec{c} = 0$

$\Rightarrow \vec{a} \cdot \vec{b} = \cos\theta = -\sqrt{3}/2 \Rightarrow \theta = 5\pi/6$

26. Let  $p = \lim_{x \rightarrow 0^+} (1 + \tan^2 \sqrt{x})^{2x}$  then  $\log p$  is equal to :-  
 (1)  $\frac{1}{4}$       (2) 2      (3) 1      (4)  $\frac{1}{2}$

Ans. (4)

Sol.  $p = e^{\lim_{x \rightarrow 0^+} \frac{1}{2} \left( \frac{\tan \sqrt{x}}{\sqrt{x}} \right)^2} = \sqrt{e}$

$\log p = \frac{1}{2}$

27. If  $0 \leq x < 2\pi$ , then the number of real values of  $x$ , which satisfy the equation  $\cos x + \cos 2x + \cos 3x + \cos 4x = 0$ , is :-  
 (1) 9      (2) 3      (3) 5      (4) 7

Ans. (4)

Sol.  $2\cos 2x \cos x + 2 \cos 3x \cos x = 0$   
 $\Rightarrow 2\cos x (\cos 2x + \cos 3x) = 0$   
 $2\cos x \cdot 2\cos 5x/2 \cos x/2 = 0$

$x = \frac{\pi}{2}, \frac{3\pi}{2}, \pi, \frac{3\pi}{5}, \frac{7\pi}{5}, \frac{7\pi}{5}, \frac{9\pi}{5}$

7 Solutions

28. The sum of all real values of  $x$  satisfying the equation  $(x^2 - 5x + 5)^{x^2 + 4x - 60} = 1$  is :-  
 (1) 5      (2) 3      (3) -4      (4) 6

Ans. (2)

Sol.  $x^2 - 5x + 5 = 1 \Rightarrow x = 1, 4$   
 $x^2 - 5x + 5 = -1 \Rightarrow x = 2, 3$   
 but 3 is rejected  
 $x^2 + 4x - 60 = 0 \Rightarrow x = -10, 6$   
 Sum = 3

29. The area (in sq. units) of the region  $\{(x, y) : y^2 \geq 2x \text{ and } x^2 + y^2 \leq 4x, x \geq 0, y \geq 0\}$  is :-

- (1)  $\frac{\pi}{2} - \frac{2\sqrt{2}}{3}$       (2)  $\pi - \frac{4}{3}$   
 (3)  $\pi - \frac{8}{3}$       (4)  $\pi - \frac{4\sqrt{2}}{3}$

Ans. (3)

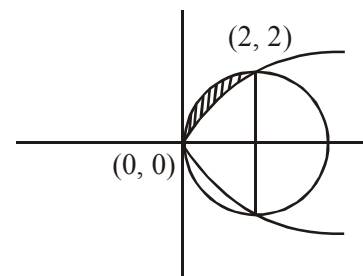

Sol.

$= \frac{\pi(2)^2}{4} - \sqrt{2} \int_0^2 \sqrt{x} dx$   
 $= \pi - \sqrt{2} \cdot \frac{2}{3} \cdot 2\sqrt{2}$   
 $= \pi - 8/3$

30. If  $f(x) + 2f\left(\frac{1}{x}\right) = 3x, x \neq 0$ , and  $S = \{x \in \mathbb{R} : f(x) = f(-x)\}$ ; then S :  
 (1) contains more than two elements.  
 (2) is an empty set.  
 (3) contains exactly one element  
 (4) contains exactly two elements

Ans. (4)

Sol.  $f(x) + 2f(1/x) = 3x \dots (1)$

$x \rightarrow \frac{1}{x} \Rightarrow f(1/x) + 2f(x) = 3/x \dots (2)$

$f(x) + 2\left(\frac{3}{x} - 2f(x)\right) = 3x$

$\Rightarrow 3f(x) = \frac{6}{x} - 3x$

$\Rightarrow f(x) = \frac{2}{x} - x$

For S  $f(x) = f(-x) \Rightarrow \frac{2}{x} - x = 0$

$\Rightarrow x = \pm\sqrt{2}$

**JEE(MAIN) – 2016 TEST PAPER WITH SOLUTION  
(HELD ON SUNDAY 03<sup>th</sup> APRIL, 2016)**

**PART B – PHYSICS**

31. A combination of capacitors is set up as shown in the figure. The magnitude of the electric field, due to a point charge  $Q$  (having a charge equal to the sum of the charges on the  $4 \mu\text{F}$  and  $9 \mu\text{F}$  capacitors), at a point  $30 \text{ m}$  from it, would equal:

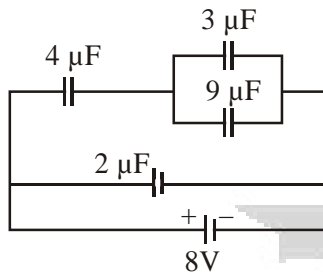

- (1)  $480 \text{ N/C}$                       (2)  $240 \text{ N/C}$   
 (3)  $360 \text{ N/C}$                       (4)  $420 \text{ N/C}$

Ans. (4)

Sol.

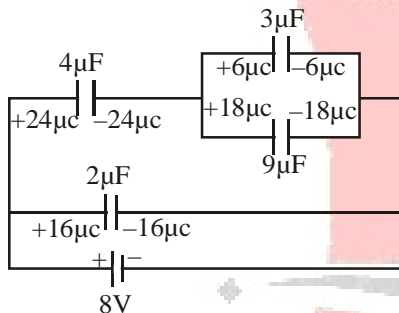

$$Q = 24 + 18 = 42 \mu\text{C}$$

$$E = \frac{KQ}{r^2}$$

$$\Rightarrow E = \frac{9 \times 10^9 \times 42 \times 10^{-6}}{(30)^2} = 420 \text{ N/C}$$

32. An observer looks at a distant tree of height  $10 \text{ m}$  with a telescope of magnifying power of  $20$ . To the observer the tree appears :

- (1)  $20$  times nearer  
 (2)  $10$  times taller  
 (3)  $10$  times nearer  
 (4)  $20$  times taller

Ans. (4)

Sol. Angular magnification is  $20$ .

33. Hysteresis loops for two magnetic materials A and B are given below :

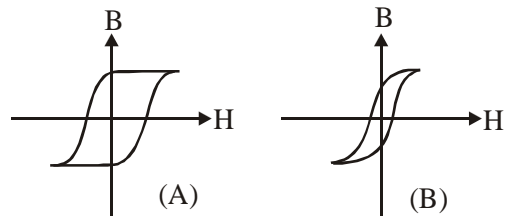

These materials are used to make magnets for electric generators, transformer core and electromagnet core. Then it is proper to use ;

- (1) B for electromagnets and transformers.  
 (2) A for electric generators and transformers.  
 (3) A for electromagnets and B for electric transformers.  
 (4) A for transformers and B for electric generators.

Ans. (1)

Sol. For electromagnet and transformers, we require the core that can be magnetised and demagnetised quickly when subjected to alternating current. From the given graphs, graph B is suitable.

34. Half-lives of two radioactive elements A and B are  $20$  minutes and  $40$  minutes, respectively. Initially, the samples have equal number of nuclei. After  $80$  minutes, the ratio of decayed numbers of A and B nuclei will be :-

- (1)  $5 : 4$                                       (2)  $1 : 16$   
 (3)  $4 : 1$                                       (4)  $1 : 4$

Ans. (1)

Sol.  $t = 80 \text{ min} = 4 T_A = 2 T_B$

$$\therefore \text{no. of nuclei of A decayed} = N_0 - \frac{N_0}{2^4} = \frac{15N_0}{16}$$

$$\therefore \text{no. of nuclei of B decayed} = N_0 - \frac{N_0}{2^2} = \frac{3N_0}{4}$$

$$\text{required ratio} = \frac{5}{4}$$



35. A particle of mass  $m$  is moving along the side of a square of side ' $a$ ', with a uniform speed  $v$  in the  $x$ - $y$  plane as shown in the figure :

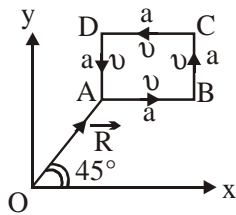

Which of the following statement is false for the angular momentum  $\vec{L}$  about the origin ?

- (1)  $\vec{L} = \frac{mv}{\sqrt{2}} R \hat{k}$  when the particle is moving from D to A
- (2)  $\vec{L} = -\frac{mv}{\sqrt{2}} R \hat{k}$  when the particle is moving from A to B
- (3)  $\vec{L} = mv \left[ \frac{R}{\sqrt{2}} - a \right] \hat{k}$  when the particle is moving from C to D
- (4)  $\vec{L} = mv \left[ \frac{R}{\sqrt{2}} + a \right] \hat{k}$  when the particle is moving from B to C

Ans. (1 or 3)

Sol.  $\vec{L} = \vec{r} \times \vec{p}$  or  $\vec{L} = rp \sin \theta \hat{n}$

or  $\vec{L} = r_{\perp} (P) \hat{n}$   
For D to A

$$\vec{L} = \frac{R}{\sqrt{2}} mV(-\hat{k})$$

For A to B

$$\vec{L} = \frac{R}{\sqrt{2}} mV(-\hat{k})$$

For C to D

$$\vec{L} = \left( \frac{R}{\sqrt{2}} + a \right) mV(\hat{k})$$

For B to C

$$\vec{L} = \left( \frac{R}{\sqrt{2}} + a \right) mV(\hat{k})$$

36. Choose the correct statement :

- (1) In frequency modulation the amplitude of the high frequency carrier wave is made to vary in proportion to the frequency of the audio signal.
- (2) In amplitude modulation the amplitude of the high frequency carrier wave is made to vary in proportion to the amplitude of the audio signal.
- (3) In amplitude modulation the frequency of the high frequency carrier wave is made to vary in proportion to the amplitude of the audio signal.
- (4) In frequency modulation the amplitude of the high frequency carrier wave is made to vary in proportion to the amplitude of the audio signal.

Ans. (2)

37. In an experiment for determination of refractive index of glass of a prism by  $i - \delta$ , plot, it was found that a ray incident at angle  $35^\circ$ , suffers a deviation of  $40^\circ$  and that it emerges at angle  $79^\circ$ . In that case which of the following is closest to the maximum possible value of the refractive index?

- (1) 1.8
- (2) 1.5
- (3) 1.6
- (4) 1.7

Ans. (2)

Sol.  $i = 35^\circ$ ,  $\delta = 40^\circ$ ,  $e = 79^\circ$

$$\delta = i + e - A$$

$$40^\circ = 35^\circ + 79^\circ - A$$

$$A = 74^\circ$$

$$\text{and } r_1 + r_2 = A = 74^\circ$$

solving these, we get  $\mu = 1.5$

Since  $\delta_{\min} < 40^\circ$

$$\mu < \frac{\sin\left(\frac{74 + 40}{2}\right)}{\sin 37}$$

$$\mu_{\max} = 1.44$$

38. 'n' moles of an ideal gas undergoes a process A → B as shown in the figure. The maximum temperature of the gas during the process will be :

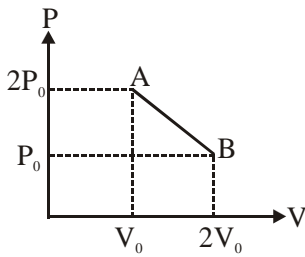

- (1)  $\frac{9P_0V_0}{nR}$  (2)  $\frac{9P_0V_0}{4nR}$  (3)  $\frac{3P_0V_0}{2nR}$  (4)  $\frac{9P_0V_0}{2nR}$

Ans. (2)

Sol. T will be max where product of PV is max.

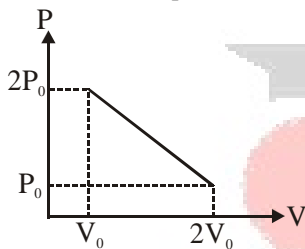

equation of line

$$P = \frac{-P_0}{V_0}V + 3P_0$$

$$PV = \frac{-P_0}{V_0}V^2 + 3P_0V = x \text{ (says)}$$

$$\left. \begin{aligned} \frac{dx}{dV} = 0 \Rightarrow V = \frac{3V_0}{2} \\ \Rightarrow P = \frac{3P_0}{2} \end{aligned} \right\} \text{here PV product is max.}$$

$$\Rightarrow T = \frac{PV}{nR} = \frac{9P_0V_0}{4nR}$$

Alternate

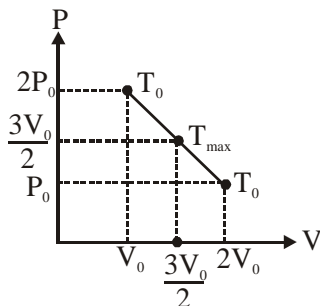

Since initial and final temperature are equal hence maximum temperature is at middle of line.

$$PV = nRT$$

$$\left(\frac{3P_0}{2}\right)\left(\frac{3V_0}{2}\right) = T_{\max} \cdot nR \Rightarrow \frac{9P_0V_0}{4nR} = T_{\max}$$

39. Two identical wires A and B, each of length 'l', carry the same current I. Wire A is bent into a circle of radius R and wire B is bent to form a square of side 'a'. If  $B_A$  and  $B_B$  are the values of magnetic field at the centres of the circle and square respectively, then the ratio  $\frac{B_A}{B_B}$  is :

- (1)  $\frac{\pi^2}{8\sqrt{2}}$  (2)  $\frac{\pi^2}{8}$   
 (3)  $\frac{\pi^2}{16\sqrt{2}}$  (4)  $\frac{\pi^2}{16}$

Ans. (1)

Sol.

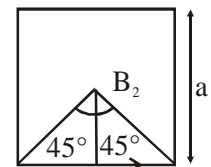
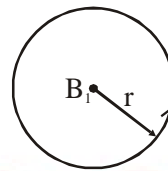

$$B_1 = \frac{\mu_0 i}{2r}$$

$$B_2 = 4 \times \frac{\mu_0}{4\pi} \times \frac{i}{\left(\frac{a}{2}\right)} \left(\frac{1}{\sqrt{2}} + \frac{1}{\sqrt{2}}\right)$$

$$\frac{B_1}{B_2} = \frac{\pi a}{4\sqrt{2}r}$$

$$l = 2\pi r = 4a$$

$$\frac{B_1}{B_2} = \frac{\pi}{4\sqrt{2}} \cdot \frac{\pi}{2}$$

$$\frac{a}{r} = \frac{2\pi}{4} = \frac{\pi}{2}$$

$$= \frac{\pi^2}{8\sqrt{2}}$$

40. A screw gauge with a pitch of 0.5 mm and a circular scale with 50 divisions is used to measure the thickness of a thin sheet of Aluminium. Before starting the measurement, it is found that when the two jaws of the screw gauge are brought in contact, the 45<sup>th</sup> division coincides with the main scale line and that the zero of the main scale is barely visible. What is the thickness of the sheet if the main scale reading is 0.5 mm and the 25<sup>th</sup> division coincides with the main scale line ?

- (1) 0.50 mm (2) 0.75 mm  
 (3) 0.80 mm (4) 0.70 mm

Ans. (3)

**Sol.** Least count =  $\frac{\text{pitch}}{\text{no. of division on circular scale}} = \frac{0.5\text{mm}}{50}$   
 LC = 0.001 mm  
 -ve zero error =  $-5 \times \text{LC} = -0.005 \text{ mm}$   
 Measured value =  
 main scale reading + screw gauge reading  
 - zero error  
 = 0.5 mm +  $\{25 \times 0.001 - (-0.05)\}$  mm  
 = 0.8 mm

**41.** For a common emitter configuration, if  $\alpha$  and  $\beta$  have their usual meanings, the **incorrect** relationship between  $\alpha$  and  $\beta$  is

- (1)  $\alpha = \frac{\beta^2}{1+\beta^2}$       (2)  $\frac{1}{\alpha} = \frac{1}{\beta} + 1$   
 (3)  $\alpha = \frac{\beta}{1-\beta}$       (4)  $\alpha = \frac{\beta}{1+\beta}$

**Ans. (1 or 3)**

**Sol.**  $\alpha = \frac{I_c}{I_e}$ ,  $\beta = \frac{I_c}{I_b}$

$$I_e = I_b + I_c$$

$$\Rightarrow \frac{I_e}{I_c} = \frac{I_b}{I_c} + 1 \Rightarrow \frac{1}{\alpha} = \frac{1}{\beta} + 1$$

$$\alpha = \frac{\beta}{1+\beta}$$

**42.** The box of a pin hole camera, of length  $L$ , has a hole of radius  $a$ . It is assumed that when the hole is illuminated by a parallel beam of light of wavelength  $\lambda$  the spread of the spot (obtained on the opposite wall of the camera) is the sum of its geometrical spread and the spread due to diffraction. The spot would then have its minimum size (say  $b_{\min}$ ) when :-

(1)  $a = \frac{\lambda^2}{L}$  and  $b_{\min} = \sqrt{4\lambda L}$

(2)  $a = \frac{\lambda^2}{L}$  and  $b_{\min} = \left(\frac{2\lambda^2}{L}\right)$

(3)  $a = \sqrt{\lambda L}$  and  $b_{\min} = \left(\frac{2\lambda^2}{L}\right)$

(4)  $a = \sqrt{\lambda L}$  and  $b_{\min} = \sqrt{4\lambda L}$

**Ans. (4)**

**Sol.** Spot size (diameter)  $b = 2\left(\frac{\lambda L}{2a}\right) + 2a$

$$a^2 + \lambda L - ab = 0 \quad \dots(i)$$

For Real roots  $b^2 - 4L\lambda \geq 0$

$$b_{\min.} = \sqrt{4\lambda L}$$

by eq. (i)  $a = \sqrt{\lambda L}$

**43.** A person trying to lose weight by burning fat lifts a mass of 10 kg upto a height of 1 m 1000 times. Assume that the potential energy lost each time he lowers the mass is dissipated. How much fat will he use up considering the work done only when the weight is lifted up? Fat supplies  $3.8 \times 10^7 \text{ J}$  of energy per kg which is converted to mechanical energy with a 20% efficiency rate. Take  $g = 9.8 \text{ ms}^{-2}$  :-

- (1)  $12.89 \times 10^{-3} \text{ kg}$       (2)  $2.45 \times 10^{-3} \text{ kg}$   
 (3)  $6.45 \times 10^{-3} \text{ kg}$       (4)  $9.89 \times 10^{-3} \text{ kg}$

**Ans. (1)**

**Sol.** Work done against gravity =  $(mgh)$  1000  
 in lifting 1000 times

$$= 10 \times 9.8 \times 10^3$$

$$= 9.8 \times 10^4 \text{ Joule}$$

20% efficiency is to converts fat into energy.

$$[20\% \text{ of } 3.8 \times 10^7 \text{ J}] \times (m) = 9.8 \times 10^4$$

(Where  $m$  is mass)

$$m = 12.89 \times 10^{-3} \text{ kg}$$

**44.** Arrange the following electromagnetic radiations per quantum in the order of increasing energy :-

A : Blue light      B : Yellow light

C : X-ray      D : Radiowave

(1) B, A, D, C

(2) D, B, A, C

(3) A, B, D, C

(4) C, A, B, D

**Ans. (2)**

**Sol.** Energy =  $\frac{hc}{\lambda}$

order of wavelength

x ray, VIBGYOR, Radiowaves

C      (A) (B)      (D)

$\therefore$  order of energy

D < B < A < C

45. An ideal gas undergoes a quasi static, reversible process in which its molar heat capacity  $C$  remains constant. If during this process the relation of pressure  $P$  and volume  $V$  is given by  $PV^n = \text{constant}$ , then  $n$  is given by (Here  $C_p$  and  $C_v$  are molar specific heat at constant pressure and constant volume, respectively) :-

(1)  $n = \frac{C - C_v}{C - C_p}$       (2)  $n = \frac{C_p}{C_v}$   
 (3)  $n = \frac{C - C_p}{C - C_v}$       (4)  $n = \frac{C_p - C}{C - C_v}$

Ans. (3)

Sol. Specific heat  $C = \frac{R}{1-n} + C_v$  for polytropic process

$$\therefore \frac{R}{1-n} + C_v = C$$

$$\frac{R}{1-n} = C - C_v \Rightarrow \frac{R}{C - C_v} = 1 - n$$

(Where  $R = C_p - C_v$ )

$$\Rightarrow n = \frac{C - C_p}{C - C_v}$$

46. A satellite is revolving in a circular orbit at a height 'h' from the earth's surface (radius of earth  $R$ ;  $h \ll R$ ). The minimum increase in its orbital velocity required, so that the satellite could escape from the earth's gravitational field, is close to : (Neglect the effect of atmosphere).

(1)  $\sqrt{gR}(\sqrt{2} - 1)$       (2)  $\sqrt{2gR}$   
 (3)  $\sqrt{gR}$       (4)  $\sqrt{gR/2}$

Ans. (1)

Sol.  $V_0 = \sqrt{\frac{GM}{R}}$  or  $\sqrt{gR}$

$$V_e = \sqrt{\frac{2GM}{R}}$$
 or  $\sqrt{2gR}$

$$\therefore \text{Increase in velocity} = \sqrt{gR}[\sqrt{2} - 1]$$

47. A galvanometer having a coil resistance of  $100\Omega$  gives a full scale deflection, when a current of  $1 \text{ mA}$  is passed through it. The value of the resistance, which can convert this galvanometer into ammeter giving a full scale deflection for a current of  $10 \text{ A}$ , is :-

- (1)  $3\Omega$       (2)  $0.01\Omega$       (3)  $2\Omega$       (4)  $0.1\Omega$

Ans. (2)

Sol.

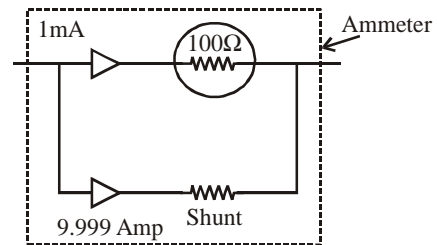

P.D. should remain same

$$1 \text{ mA} \times 100 = 9.999 \text{ R}$$

$$R = \frac{1}{99.99} = 0.01\Omega$$

48. Radiation of wavelength  $\lambda$ , is incident on a photocell. The fastest emitted electron has speed

$v$ . If the wavelength of changed to  $\frac{3\lambda}{4}$ , the speed of the fastest emitted electron will be :-

- (1)  $= v\left(\frac{3}{5}\right)^{1/2}$       (2)  $> v\left(\frac{4}{3}\right)^{1/2}$   
 (3)  $< v\left(\frac{4}{3}\right)^{1/2}$       (4)  $= v\left(\frac{4}{3}\right)^{1/2}$

Ans. (2)

Sol.  $E = (KE)_{\text{max}} + \phi$

$$\left[ \frac{hc}{\lambda} = (KE)_{\text{max}} + \phi \right] \dots (1)$$

$$\frac{4}{3} \frac{hc}{\lambda} = \left( \frac{4}{3} KE_{\text{max}} + \frac{\phi}{3} \right) + \phi$$

$$(KE)_{\text{max}} \text{ for fastest emitted electron} = \frac{1}{2} mV'^2 + \phi$$

$$\frac{1}{2} mV'^2 = \frac{4}{3} \left( \frac{1}{2} mV^2 \right) + \frac{\phi}{3}$$

$$V' > V \left( \frac{4}{3} \right)^{1/2}$$

49. If a, b, c, d are inputs to a gate and x is its output, then as per the following time graph, the gate is

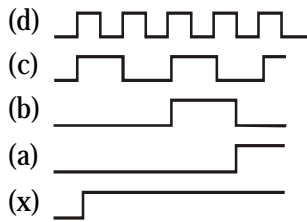

- (1) NAND (2) NOT  
(3) AND (4) OR

Ans. (4)

Sol. Output of OR gate is 0 when all inputs are 0 & output is 1 when atleast one of the input is 1. Observing output x :- It is 0 when all inputs are 0 & it is 1 when atleast one of the inputs is 1.  $\therefore$  OR gate

50. The region between two concentric spheres of radii 'a' and 'b', respectively (see figure), has volume

charge density  $\rho = \frac{A}{r}$ , where A is a constant and

r is the distance from the centre. At the centre of the spheres is a point charge Q. The value of A such that the electric field in the region between the spheres will be constant, is :-

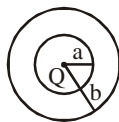

- (1)  $\frac{2Q}{\pi a^2}$  (2)  $\frac{Q}{2\pi a^2}$   
(3)  $\frac{Q}{2\pi(b^2 - a^2)}$  (4)  $\frac{2Q}{\pi(a^2 - b^2)}$

Ans. (2)

Sol. Gaussian surface at distance r from center

$$Q + \int_a^r \frac{A}{r} 4\pi r^2 dr = E 4\pi r^2$$

$$E = \frac{Q + 2\pi A r^2 - 2\pi A a^2}{4\pi r^2 \epsilon_0}$$

make E independent of r then

$$Q - 2\pi a^2 A = 0 \Rightarrow A = \frac{Q}{2\pi a^2}$$

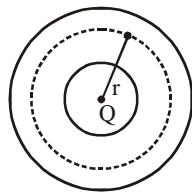

51. A student measures the time period of 100 oscillations of a simple pendulum four times. The data set is 90 s, 91 s, 95 s and 92 s. If the minimum division in the measuring clock is 1 s, then the reported mean time should be :-

- (1)  $92 \pm 3$  s (2)  $92 \pm 2$  s  
(3)  $92 \pm 5.0$  s (4)  $92 \pm 1.8$  s

Ans. (2)

Sol.  $T_{AV} = 92$  s

$$(\Delta T)_{\text{mean}} = 1.5$$

since uncertainty is 1.5 s

so digit 2 in 92 is uncertain.

so reported mean time should be

$$92 \pm 2$$

Ref : NCERT (XI<sup>th</sup>) Ex. 2.7, Page. 25

52. The temperature dependence of resistances of Cu and undoped Si in the temperature range 300-400K, is best described by :-

- (1) Linear decrease for Cu, linear decrease for Si.  
(2) Linear increase for Cu, linear increase for Si.  
(3) Linear increase for Cu, exponential increase for Si  
(4) Linear increase for Cu, exponential decrease for Si

Ans. (4)

Sol. Factual

Cu is conductor so with increase in temperature, resistance will increase

Si is semiconductor so with increase in temperature resistance will decrease

53. Identify the semiconductor devices whose characteristics are given below, in the order (a), (b), (c), (d) :-

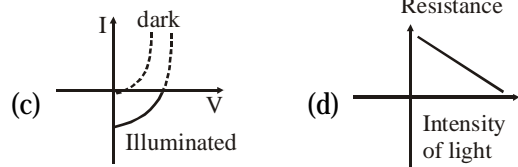
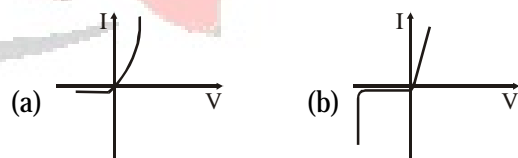

- (1) Zener diode, Solar cell, Simple diode, Light dependent resistance  
(2) Simple diode, Zener diode, Solar cell, Light dependent resistance  
(3) Zener diode, Simple diode, Light dependent resistance, Solar cell  
(4) Solar cell, Light dependent resistance, Zener diode, Simple diode

Ans. (2)

Sol. Factual

54. A roller is made by joining together two cones at their vertices O. It is kept on two rails AB and CD which are placed asymmetrically (see figure), with its axis perpendicular to CD and its centre O at the centre of line joining AB and CD (see figure). It is given a light push so that it starts rolling with its centre O moving parallel to CD in the direction shown. As it moves, the roller will tend to :-

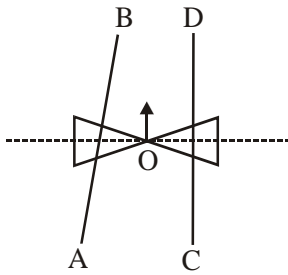

- (1) turn left and right alternately.
- (2) turn left.
- (3) turn right.
- (4) go straight.

Ans. (2)



Sol.

Say the distance of central line from instantaneous axis of rotation is r.

Then r from the point on left becomes lesser than that for right.

So  $v_{\text{left point}} = \omega r' < \omega r = v_{\text{right point}}$

So the roller will turn to left.

55. A pendulum clock loses 12s a day if the temperature is  $40^\circ\text{C}$  and gains 4s a day if the temperature is  $20^\circ\text{C}$ . The temperature at which the clock will show correct time, and the coefficient of linear expansion ( $\alpha$ ) of the metal of the pendulum shaft are respectively :-

- (1)  $55^\circ\text{C}$  ;  $\alpha = 1.85 \times 10^{-2} / ^\circ\text{C}$
- (2)  $25^\circ\text{C}$  ;  $\alpha = 1.85 \times 10^{-5} / ^\circ\text{C}$
- (3)  $60^\circ\text{C}$  ;  $\alpha = 1.85 \times 10^{-4} / ^\circ\text{C}$
- (4)  $30^\circ\text{C}$  ;  $\alpha = 1.85 \times 10^{-3} / ^\circ\text{C}$

Ans. (2)

Sol.  $T = 2\pi\sqrt{\frac{l}{g}}$

$$\frac{\Delta T}{T} = \frac{1}{2} \frac{\Delta l}{l}$$

When clock gain 12 sec

$$\frac{12}{T} = \frac{1}{2} \alpha (40 - \theta) \quad \dots(1)$$

When clock lose 4 sec.

$$\frac{4}{T} = \frac{1}{2} \alpha (\theta - 20) \quad \dots(2)$$

From equation (1) & (2)

$$3 = \frac{40 - \theta}{\theta - 20}$$

$$3\theta - 60 = 40 - \theta$$

$$4\theta = 100$$

$$\theta = 25^\circ\text{C}$$

from equation (1)

$$\frac{12}{T} = \frac{1}{2} \alpha (40 - 25)$$

$$\frac{12}{24 \times 3600} = \frac{1}{2} \alpha \times 15$$

$$\alpha = \frac{24}{24 \times 3600 \times 15}$$

$$\alpha = 1.85 \times 10^{-5} / ^\circ\text{C}$$

56. A uniform string of length 20m is suspended from a rigid support. A short wave pulse is introduced at its lowest end. It starts moving up the string. The time taken to reach the support is :-

(take  $g = 10 \text{ ms}^{-2}$ )

- (1)  $\sqrt{2} \text{ s}$
- (2)  $2\pi\sqrt{2} \text{ s}$
- (3)  $2 \text{ s}$
- (4)  $2\sqrt{2} \text{ s}$

Ans. (4)

Sol. Velocity at point P =  $\sqrt{\frac{m}{L} \frac{gx}{m/L}}$

$$v = \sqrt{gx}$$

$$\frac{dx}{dt} = \sqrt{gx}$$

$$\int_0^{20} \frac{dx}{\sqrt{x}} = \int_0^t \sqrt{g} dt$$

$$t = 2\sqrt{2} \text{ sec}$$

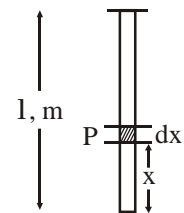

57. A point particle of mass, moves along the uniformly rough track PQR as shown in the figure. The coefficient of friction, between the particle and the rough track equals  $\mu$ . The particle is released, from rest, from the point P and it comes to rest at a point R. The energies, lost by the ball, over the parts, PQ and PR, of the track, are equal to each other, and no energy is lost when particle changes direction from PQ to QR. The values of the coefficient of friction  $\mu$  and the distance  $x(=QR)$  are, respectively close to :-

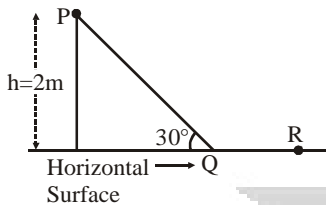

- (1) 0.29 and 6.5 m      (2) 0.2 and 6.5 m  
 (3) 0.2 and 3.5 m      (4) 0.29 and 3.5 m

Ans. (4)  
 Sol.

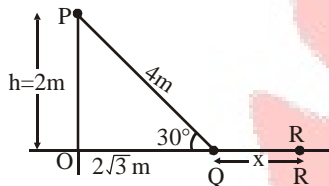

Energy lost over path PQ is  $= \mu mg \cos\theta \times 4$   
 Energy lost over path QR is  $= \mu mgx$   
 $\mu mgx = \mu mg \cos\theta \times 4$   
 $x = \cos\theta \times 4$

$$x = 2\sqrt{3} = 3.45 \text{ m}$$

From Q to R energy loss is half of the total energy loss.

$$\mu mgx = \frac{1}{2} \times mgh \Rightarrow \mu = 0.29$$

58. A pipe open at both ends has a fundamental frequency  $f$  in air. The pipe is dipped vertically in water so that half of it is in water. The fundamental frequency of the air column is now :-

- (1)  $f$       (2)  $\frac{f}{2}$       (3)  $\frac{3f}{4}$       (4)  $2f$

Ans. (1)

Sol.



$$\frac{\lambda}{2} = l$$

$$\lambda = 2l$$

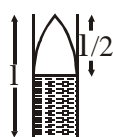

$$\frac{\lambda}{4} = \frac{\lambda l}{2}$$

$$\lambda = 2l$$

$$v = f\lambda$$

$$f = \frac{v}{\lambda} = \frac{v}{2l}$$

$$f' = f$$

$$v = f'\lambda$$

$$f' = \frac{v}{\lambda} = \frac{v}{2l} = f$$

59. A particle performs simple harmonic motion with amplitude  $A$ . Its speed is trebled at the instant that it is at a distance  $\frac{2A}{3}$  from equilibrium position.

The new amplitude of the motion is :-

- (1)  $\frac{7A}{3}$       (2)  $\frac{A}{3}\sqrt{41}$       (3)  $3A$       (4)  $A\sqrt{3}$

Ans. (1)

Sol. Let new amplitude is  $A'$   
 initial velocity

$$v^2 = \omega^2 \left( A^2 - \left( \frac{2A}{3} \right)^2 \right) \quad \dots(1)$$

Where  $A$  is initial amplitude &  $\omega$  is angular frequency.

Final velocity

$$(3v)^2 = \omega^2 \left( A'^2 - \left( \frac{2A}{3} \right)^2 \right) \quad \dots(2)$$

From equation & equation (2)

$$\frac{1}{9} = \frac{A^2 - \frac{4A^2}{9}}{A'^2 - \frac{4A^2}{9}}$$

$$A' = \frac{7A}{3}$$

60. An arc lamp requires a direct current of 10A at 80V to function. If it is connected to a 220V (rms), 50 Hz AC supply, the series inductor needed for it to work is close to :-

- (1) 0.065 H      (2) 80 H  
 (3) 0.08 H      (4) 0.044 H

Ans. (1)

Sol.  $I = 10\text{A}$   
 $V = 80\text{v}$   
 $R = 8\Omega$

$$10 = \frac{220}{\sqrt{8^2 + X_L^2}}$$

$$X_L^2 + 64 = 484$$

$$X_L = \sqrt{420}$$

$$2\pi \times 50L = \sqrt{420}$$

$$L = \frac{\sqrt{420}}{100\pi}$$

$$L = 0.065 \text{ H}$$

**JEE(MAIN) – 2016 TEST PAPER WITH SOLUTION  
(HELD ON SUNDAY 03<sup>th</sup> APRIL, 2016)**

**PART C – CHEMISTRY**

61. Which one of the following statements about water is **FALSE** ?

- (1) Ice formed by heavy water sinks in normal water.
- (2) Water is oxidized to oxygen during photosynthesis.
- (3) Water can act both as an acid and as a base.
- (4) There is extensive intramolecular hydrogen bonding in the condensed phase.

**Ans. (4)**

**Sol.** (1) Ice formed by heavy water sinks in normal water due to higher density of  $D_2O$  than normal water.

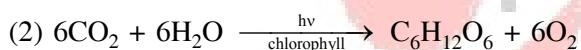

- (3) Water can show amphiprotic nature and hence water can act both as an acid a base.
- (4) There is extensive intermolecular hydrogen bonding in the condensed phase instead of intramolecular H-bonding.

62. The concentration of fluoride, lead, nitrate and iron in a water sample from an underground lake was found to be 1000 ppb, 40 ppb, 100 ppm and 0.2 ppm, respectively. This water is unsuitable for drinking due to high concentration of :-

- (1) Iron
- (2) Fluoride
- (3) Lead
- (4) Nitrate

**Ans. (4)**

**Sol.**

Parameters	Maximum prescribed conc. in drinking water
Iron	0.2 ppm
Fluoride	1.5 ppm
Lead	50 ppb
Nitrate	50 ppm

Hence the concentration of nitrate in a given water sample exceeds from the upper limit as given above.

63. Galvanization is applying a coating of :-

- (1) Zn
- (2) Pb
- (3) Cr
- (4) Cu

**Ans. (1)**

**Sol.** Galvanization is the process of applying a protective zinc coating of steel or iron, to prevent rusting.

64. Which one of the following complexes shows optical isomerism :-

- (1)  $[Co(NH_3)_4Cl_2]Cl$
  - (2)  $[Co(NH_3)_3Cl_3]$
  - (3)  $cis[Co(en)_2Cl_2]Cl$
  - (4)  $trans[Co(en)_2Cl_2]Cl$
- (en = ethylenediamine)

**Ans. (3)**

**Sol.**

- Complex  $[Co(NH_3)_4Cl_2]Cl$  have two G.I. which are optically inactive due to presence of plane of symmetry.
- Complex  $[Co(NH_3)_3Cl_3]$  also have two optically inactive geometrical isomers due to presence of plane of symmetry.
- Complex  $cis[Co(en)_2Cl_2]Cl$  is optically active due to formation of non-superimposable mirror image.

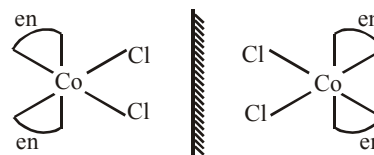

- $trans[Co(en)_2Cl_2]Cl$

Complex  $trans[Co(en)_2Cl_2]Cl$  is optically inactive.



65. Two closed bulbs of equal volume (V) containing an ideal gas initially at pressure  $p_i$  and temperature  $T_1$  are connected through a narrow tube of negligible volume as shown in the figure below. The temperature of one of the bulbs is then raised to  $T_2$ . The final pressure  $p_f$  is :-

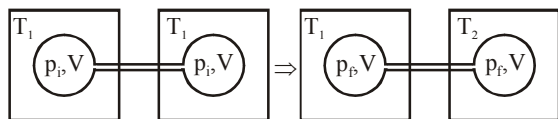

(1)  $2p_i \left( \frac{T_1 T_2}{T_1 + T_2} \right)$       (2)  $p_i \left( \frac{T_1 T_2}{T_1 + T_2} \right)$

(3)  $2p_i \left( \frac{T_1}{T_1 + T_2} \right)$       (4)  $2p_i \left( \frac{T_2}{T_1 + T_2} \right)$

Ans. (4)

Sol. Initial moles and final moles are equal

$$(n_r)_i = (n_r)_f$$

$$\frac{P_i V}{RT_1} + \frac{P_i V}{RT_1} = \frac{P_f V}{RT_1} + \frac{P_f V}{RT_2}$$

$$2 \frac{P_i}{T_1} = \frac{P_f}{T_1} + \frac{P_f}{T_2}$$

$$P_f = \frac{2 P_i T_2}{T_1 + T_2}$$

66. The heats of combustion of carbon and carbon monoxide are  $-393.5$  and  $-285.5$  kJ mol<sup>-1</sup>, respectively. The heat of formation (in kJ) of carbon monoxide per mole is :-

(1)  $-110.5$  (2)  $110.5$  (3)  $676.5$  (4)  $-676.5$

Ans. (1)

Sol.  $C_{(s)} + \frac{1}{2} O_{2(g)} \longrightarrow CO_{(g)} ; \Delta H_f = \Delta H_f (CO)$

$$\Delta H_f = \Delta H_C(C) - \Delta H_C(CO)$$

$$= -393.5 + 283.5$$

$$= -110 \text{ kJ}$$

67. At 300 K and 1 atm, 15 mL of a gaseous hydrocarbon requires 375 mL air containing 20% O<sub>2</sub> by volume for complete combustion. After combustion the gases occupy 330 mL. Assuming that the water formed is in liquid form and the volumes were measured at the same temperature and pressure, the formula of the hydrocarbon is :-

(1) C<sub>4</sub>H<sub>10</sub> (2) C<sub>3</sub>H<sub>6</sub> (3) C<sub>3</sub>H<sub>8</sub> (4) C<sub>4</sub>H<sub>8</sub>

Ans. (Bonus or 3)

Sol. Volume of N<sub>2</sub> in air =  $375 \times 0.8 = 300$  ml  
 volume of O<sub>2</sub> in air =  $375 \times 0.2 = 75$  ml

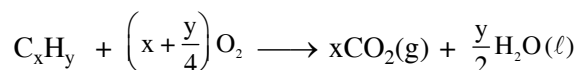

$$15 \text{ ml} \quad 15 \left( x + \frac{y}{4} \right)$$

$$0 \quad 0 \quad 15x \quad -$$

After combustion total volume

$$330 = V_{N_2} + V_{CO_2}$$

$$330 = 300 + 15x$$

$$x = 2$$

Volume of O<sub>2</sub> used

$$15 \left( x + \frac{y}{4} \right) = 75$$

$$x + \frac{y}{4} = 5$$

$$y = 12$$

So hydrocarbon is = C<sub>2</sub>H<sub>12</sub>

none of the option matches it therefore it is a **BONUS**.

Alternatively

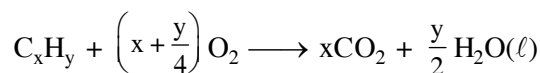

$$15 \quad 15 \left( x + \frac{y}{4} \right)$$

$$0 \quad 0 \quad 15x \quad -$$

Volume of O<sub>2</sub> used

$$15 \left( x + \frac{y}{4} \right) = 75$$

$$x + \frac{y}{4} = 5$$

If further information (i.e., 330 ml) is neglected, **option (3)** only satisfy the above equation.

68. Decomposition of  $\text{H}_2\text{O}_2$  follows a first order reaction. In fifty minutes the concentration of  $\text{H}_2\text{O}_2$  decreases from 0.5 to 0.125 M in one such decomposition. When the concentration of  $\text{H}_2\text{O}_2$  reaches 0.05 M, the rate of formation of  $\text{O}_2$  will be :-

- (1)  $1.34 \times 10^{-2} \text{ mol min}^{-1}$
- (2)  $6.93 \times 10^{-2} \text{ mol min}^{-1}$
- (3)  $6.93 \times 10^{-4} \text{ mol min}^{-1}$
- (4)  $2.66 \text{ L min}^{-1}$  at STP

Ans. (3)

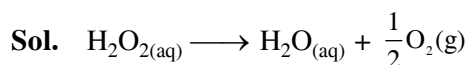

$$k = \frac{1}{t} \ln \left( \frac{a_0}{a_t} \right)$$

$$= \frac{1}{50} \ln \left( \frac{0.5}{0.125} \right)$$

$$= \frac{1}{50} \ln 4 \text{ min}^{-1}$$

$$\frac{\text{Rate of disappearance of } \text{H}_2\text{O}_2}{1} = \frac{\text{Rate of appearance of } \text{O}_2}{\frac{1}{2}}$$

$$(\text{Rate})_{\text{O}_2} = \frac{1}{2} \times (\text{Rate})_{\text{H}_2\text{O}_2}$$

$$= \frac{1}{2} k [\text{H}_2\text{O}_2]$$

$$= \frac{1}{2} \times \frac{1}{50} \times \ln 4 \times 0.05$$

$$= 6.93 \times 10^{-4} \text{ M min}^{-1}$$

69. The pair having the same magnetic moment is:-  
[At. No.: Cr = 24, Mn = 25, Fe = 26, Co = 27]

- (1)  $[\text{CoCl}_4]^{2-}$  and  $[\text{Fe}(\text{H}_2\text{O})_6]^{2+}$
- (2)  $[\text{Cr}(\text{H}_2\text{O})_6]^{2+}$  and  $[\text{CoCl}_4]^{2-}$
- (3)  $[\text{Cr}(\text{H}_2\text{O})_6]^{2+}$  and  $[\text{Fe}(\text{H}_2\text{O})_6]^{2+}$
- (4)  $[\text{Mn}(\text{H}_2\text{O})_6]^{2+}$  and  $[\text{Cr}(\text{H}_2\text{O})_6]^{2+}$

Ans. (3)

Sol. In option (1) :  $[\text{CoCl}_4]^{2-}$ ,  $\text{Co}^{2+}$  ( $3d^7$ ) with W.F.L.,

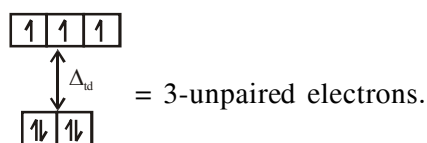

&  $[\text{Fe}(\text{H}_2\text{O})_6]^{2+}$ ,  $\text{Fe}^{2+}$  ( $3d^6$ ) with W.F.L.,

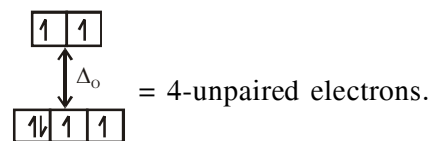

In option (2) :  $[\text{Cr}(\text{H}_2\text{O})_6]^{2+}$ ,  $\text{Cr}^{2+}$  ( $3d^4$ ) with W.F.L.,

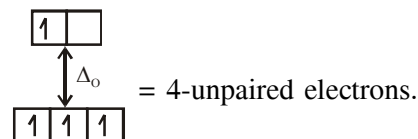

&  $[\text{CoCl}_4]^{2-}$ ,  $\text{Co}^{2+}$  ( $3d^7$ ) with W.F.L.,

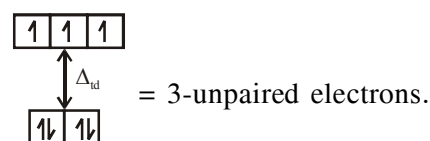

In option (3) :  $[\text{Cr}(\text{H}_2\text{O})_6]^{2+}$ ,  $\text{Cr}^{2+}$  ( $3d^4$ ) with W.F.L.,

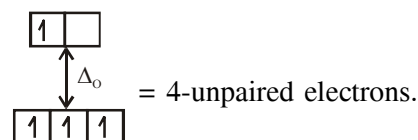

&  $[\text{Fe}(\text{H}_2\text{O})_6]^{2+}$ ,  $\text{Fe}^{2+}$  ( $3d^6$ ) with W.F.L.,

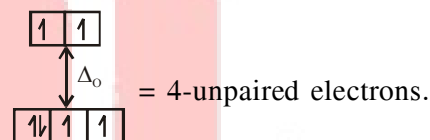

Here both complexes have same unpaired electrons i.e. = 4

In option (4) :  $[\text{Mn}(\text{H}_2\text{O})_6]^{2+}$ ,  $\text{Mn}^{2+}$  ( $3d^5$ ) with

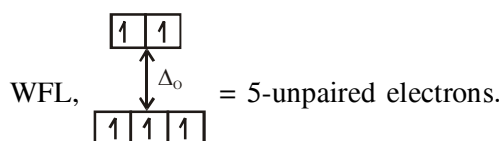

&  $[\text{Cr}(\text{H}_2\text{O})_6]^{2+}$ ,  $\text{Cr}^{2+}$  ( $3d^4$ ) with W.F.L.,

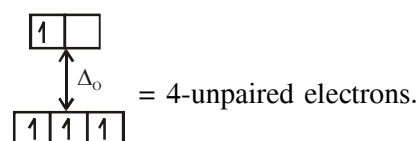

70. The species in which the N atom is in a state of sp hybridization is :-

- (1) NO<sub>2</sub> (2) NO<sub>2</sub><sup>+</sup> (3) NO<sub>2</sub><sup>-</sup> (4) NO<sub>3</sub><sup>-</sup>

Ans. (2)

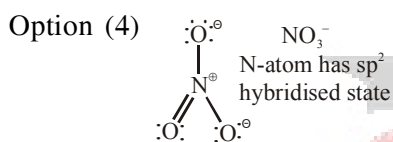
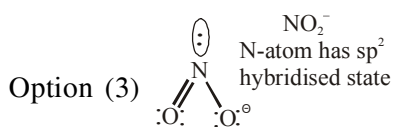
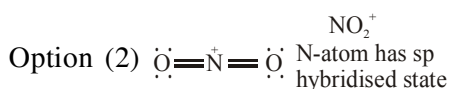
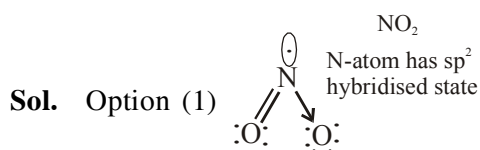

71. Thiol group is present in :-

- (1) Methionine (2) Cytosine  
(3) Cystine (4) Cysteine

Ans. (4)

Sol. Among 20 naturally occurring amino acids "Cysteine" has '-SH' or thiol functional group.

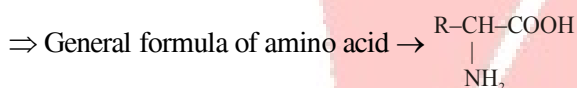

⇒ Value of R = -CH<sub>2</sub>-SH in cysteine.

72. The pair in which phosphorous atoms have a formal oxidation state of +3 is :-

- (1) Pyrophosphorous and pyrophosphoric acids  
(2) Orthophosphorous and pyrophosphorous acids  
(3) Pyrophosphorous and hypophosphoric acids  
(4) Orthophosphorous and hypophosphoric acids

Ans. (2)

Acid	Formula	Formal oxidation state of phosphorous
Pyrophosphorous acid	H <sub>4</sub> P <sub>2</sub> O <sub>5</sub>	+3
Pyrophosphoric acid	H <sub>4</sub> P <sub>2</sub> O <sub>7</sub>	+5
Orthophosphorous acid	H <sub>3</sub> PO <sub>3</sub>	+3
Hypophosphoric acid	H <sub>4</sub> P <sub>2</sub> O <sub>6</sub>	+4

Sol.

Both pyrophosphorous and orthophosphorous acids have +3 formal oxidation state

73. The distillation technique most suited for separating glycerol from spent-lye in the soap industry is :

- (1) Distillation under reduced pressure  
(2) Simple distillation  
(3) Fractional distillation  
(4) Steam distillation

Ans. (1)

Sol. (1) Distillation under reduced pressure.

Glycerol (B.P. 290°C) is separated from spent lye in the soap industry by distillation under reduced pressure, as for simple distillation very high temperature is required which might decompose the component.

74. Which one of the following ores is best concentrated by froth floatation method ?

- (1) Malachite  
(2) Magnetite  
(3) Siderite  
(4) Galena

Ans. (4)

Sol. Froth floatation method is mainly applicable for sulphide ores.

- (1) Malachite ore : Cu(OH)<sub>2</sub> . CuCO<sub>3</sub>  
(2) Magnetite ore : Fe<sub>3</sub>O<sub>4</sub>  
(3) Siderite ore : FeCO<sub>3</sub>  
(4) Galena ore : PbS (Sulphide Ore)

75. Which of the following atoms has the highest first ionization energy ?

- (1) Sc (2) Rb (3) Na (4) K

Ans. (1)

Sol. Due to poor shielding of d-electrons in Sc, Z<sub>eff</sub> of Sc becomes more so that ionisation energy of Sc is more than Na, K and Rb.

76. In the Hofmann bromamide degradation reaction, the number of moles of NaOH and Br<sub>2</sub> used per mole of amine produced are :

- (1) Four moles of NaOH and one mole of Br<sub>2</sub>  
(2) One mole of NaOH and one mole of Br<sub>2</sub>  
(3) Four moles of NaOH and two moles of Br<sub>2</sub>  
(4) Two moles of NaOH and two moles of Br<sub>2</sub>

Ans. (1)

Sol. 4 moles of NaOH and one mole of Br<sub>2</sub> is required during production of one mole of amine during Hoffmann's bromamide degradation reaction.

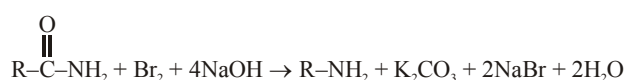

## JEE(MAIN)-2016

77. Which of the following compounds is metallic and ferromagnetic ?

- (1)  $\text{MnO}_2$                       (2)  $\text{TiO}_2$   
 (3)  $\text{CrO}_2$                       (4)  $\text{VO}_2$

**Ans. (3)**

**Sol.**  $\text{CrO}_2$  is metallic as well as ferromagnetic

78. Which of the following statements about low density polythene is FALSE ?

- (1) It is used in the manufacture of buckets, dust-bins etc.  
 (2) Its synthesis requires high pressure  
 (3) It is a poor conductor of electricity  
 (4) Its synthesis requires dioxygen or a peroxide initiator as a catalyst.

**Ans. (1)**

**Sol.** Low density polythene : It is obtained by the polymerisation of ethene under high pressure of 1000-2000 atm. at a temp. of 350 K to 570 K in the presence of traces of dioxygen or a peroxide initiator (cont).

Low density polythene is chemically inert and poor conductor of electricity. It is used for manufacture of squeeze bottles, toys and flexible pipes.

79. 2-chloro-2-methylpentane on reaction with sodium methoxide in methanol yields :

- (a)  $\text{C}_2\text{H}_5\text{CH}_2\overset{\text{CH}_3}{\underset{\text{CH}_3}{\text{C}}}-\text{OCH}_3$       (b)  $\text{C}_2\text{H}_5\text{CH}_2\overset{\text{CH}_3}{\text{C}}=\text{CH}_2$   
 (c)  $\text{C}_2\text{H}_5\text{CH}_2=\overset{\text{CH}_3}{\text{C}}-\text{CH}_3$

- (1) (a) and (b)                      (2) All of these  
 (3) (a) and (c)                      (4) (c) only

**Ans. (2)**

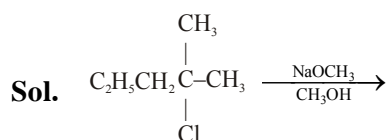

possible mechanism which takes place is  $\text{E}^2$  &  $\text{SN}^1$  mechanism. Hence possible products are.

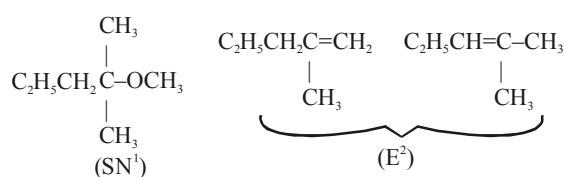

80. A stream of electrons from a heated filament was passed between two charged plates kept at a potential difference V esu. If e and m are charge and mass of an electron respectively, then the value of  $h/\lambda$  (where  $\lambda$  is wavelength associated with electron wave) is given by :

- (1)  $\sqrt{2meV}$                       (2)  $meV$   
 (3)  $2meV$                       (4)  $\sqrt{meV}$

**Ans. (1)**

**Sol.** As electron of charge 'e' is passed through 'V' volt, kinetic energy of electron becomes = 'eV'

As wavelength of  $e^-$  wave ( $\lambda$ ) =  $\frac{h}{\sqrt{2m.K.E.}}$

$$\lambda = \frac{h}{\sqrt{2meV}}$$

$$\therefore \frac{h}{\lambda} = \sqrt{2meV}$$

81. 18 g glucose ( $\text{C}_6\text{H}_{12}\text{O}_6$ ) is added to 178.2 g water. The vapour pressure of water (in torr) for this aqueous solution is :

- (1) 759.0                      (2) 7.6  
 (3) 76.0                      (4) 752.4

**Ans. (4)**

**Sol.** Assuming temperature to be  $100^\circ\text{C}$

Relative lowering of vapour pressure

Equation  $\frac{P^0 - P^s}{P^0} = X_{\text{solute}} = \frac{n}{n + N}$

Modified form of equation is  $\frac{P^0 - P_s}{P_s} = \frac{n}{N}$

$P^0 = 760$  torr

$P_s = ?$

$$\frac{760 - P_s}{P_s} = \frac{18/180}{178.2/18}$$

$P_s = 752.4$  torr

82. The product of the reaction given below is :

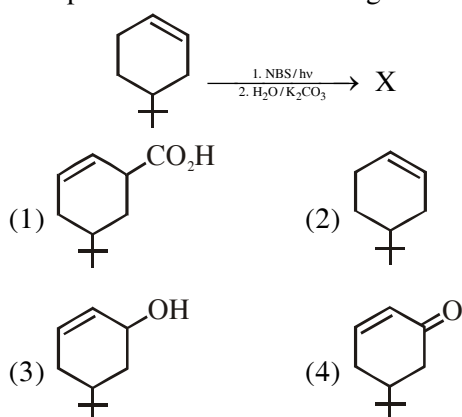

Ans. (3)

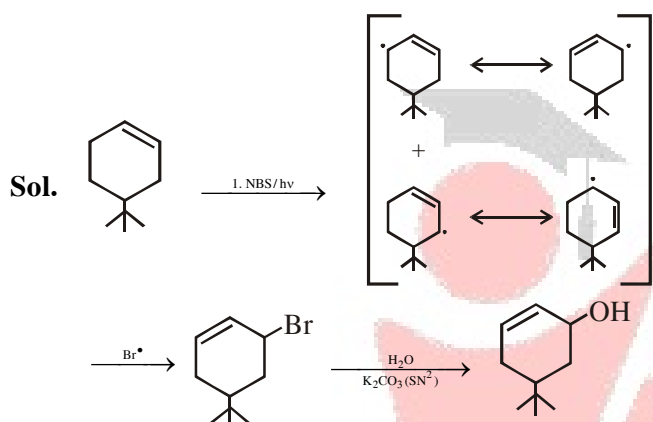

83. The hottest region of Bunsen flame shown in the figure below is :

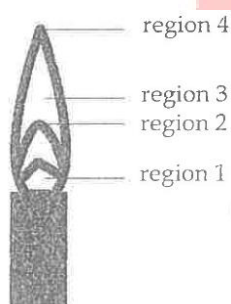

- (1) region 4                      (2) region 1  
 (3) region 2                      (4) region 3

Ans. (3)

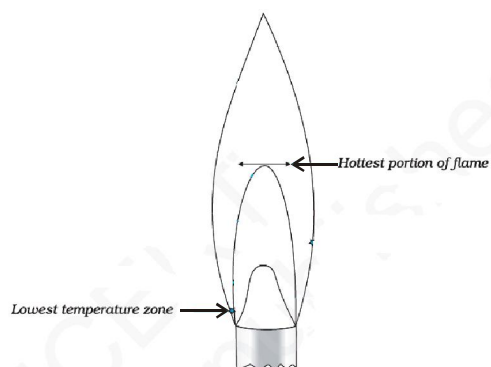

84. The reaction of zinc with dilute and concentrated nitric acid, respectively produces :

- (1) NO<sub>2</sub> and N<sub>2</sub>O              (2) N<sub>2</sub>O and NO<sub>2</sub>  
 (3) NO<sub>2</sub> and NO               (4) NO and N<sub>2</sub>O

Ans. (2)

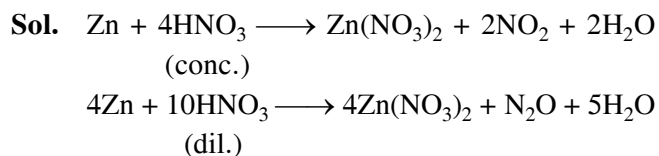

85. Which of the following is an anionic detergent ?

- (1) Glyceryl oleate  
 (2) Sodium stearate  
 (3) Sodium lauryl sulphate  
 (4) Cetyltrimethyl ammonium bromide

Ans. (3)

Sol. (1) Anionic detergent :

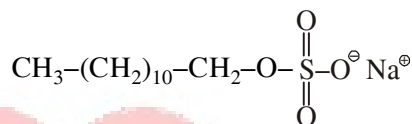

Sodium Lauryl sulfate is example of anionic detergent  
 These are sodium salts of sulphonated long chain alcohols or hydrocarbons.

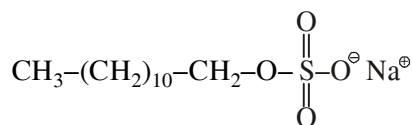
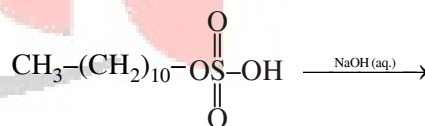

Sodium lauryl sulphate (anionic detergent)

(2) Cationic detergent

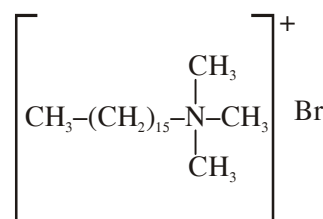

Cetyl trimethyl ammonium bromide is an example of cationic detergent

(3) C<sub>17</sub>H<sub>35</sub>CO<sub>2</sub>Na : Sodium stearate (soap)

## JEE(MAIN)-2016

**86.** The reaction of propene with HOCl ( $\text{Cl}_2 + \text{H}_2\text{O}$ ) proceeds through the intermediate :

- (1)  $\text{CH}_3\text{-CHCl-CH}_2^+$
- (2)  $\text{CH}_3\text{-CH}^+\text{-CH}_2\text{-OH}$
- (3)  $\text{CH}_3\text{-CH}^+\text{-CH}_2\text{-Cl}$
- (4)  $\text{CH}_3\text{-CH(OH)-CH}_2^+$

**Ans. (3)**

**Sol.**

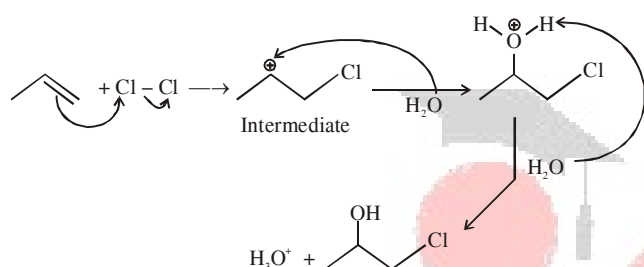

**87.** For a linear plot of  $\log(x/m)$  versus  $\log p$  in a Freundlich adsorption isotherm, which of the following statements is correct ? ( $k$  and  $n$  are constants)

- (1)  $\log(1/n)$  appears as the intercept
- (2) Both  $k$  and  $1/n$  appear in the slope term
- (3)  $1/n$  appears as the intercept
- (4) Only  $1/n$  appears as the slope

**Ans. (4)**

**Sol.** According to Freundlich isotherm

$$\frac{x}{m} = k \cdot p^{1/n}$$

$$\log \frac{x}{m} = \log k + \frac{1}{n} \log p$$

So intercept is  $\log k$  and slope is  $\frac{1}{n}$

**88.** The main oxides formed on combustion of Li, Na and K in excess of air are respectively :

- (1)  $\text{Li}_2\text{O}$ ,  $\text{Na}_2\text{O}_2$  and  $\text{KO}_2$
- (2)  $\text{Li}_2\text{O}$ ,  $\text{Na}_2\text{O}$  and  $\text{KO}_2$
- (3)  $\text{LiO}_2$ ,  $\text{Na}_2\text{O}_2$  and  $\text{K}_2\text{O}$
- (4)  $\text{Li}_2\text{O}_2$ ,  $\text{Na}_2\text{O}_2$  and  $\text{KO}_2$

**Ans. (1)**

**Sol.** The stability of the oxide of alkali metals depends upon the comparability of size of cation and anion.

Therefore the main oxide of alkali metals formed on excess of air are as follows :

Li	$\text{Li}_2\text{O}$
Na	$\text{Na}_2\text{O}_2$
K	$\text{KO}_2$
Rb	$\text{RbO}_2$
Cs	$\text{CsO}_2$

**89.** The equilibrium constants at 298 K for a reaction  $\text{A} + \text{B} \rightleftharpoons \text{C} + \text{D}$  is 100. If the initial concentration of all the four species were 1 M each, then equilibrium concentration of D (in  $\text{mol L}^{-1}$ ) will be :

- (1) 1.182
- (2) 0.182
- (3) 0.818
- (4) 1.818

**Ans. (4)**

**Sol.**  $\text{A} + \text{B} \rightleftharpoons \text{C} + \text{D}$        $K = 100$

$$Q = \frac{1 \times 1}{1 \times 1} = 1$$

$\therefore Q < K$  so reaction moves in forward reaction

	A	+	B	$\rightleftharpoons$	C	+	D
Initial	1		1		10		10
At equ.	1-x		1-x		1+x		1+x

$$\frac{(1+x)^2}{(1-x)^2} = 100 \Rightarrow \frac{1+x}{1-x} = 10$$

$$1+x = 10-10x \Rightarrow x = \frac{9}{11}$$

$$\therefore [\text{D}] = 1+x = 1 + \frac{9}{11} = 1.818 \text{ M}$$

90. The absolute configuration of :

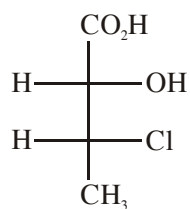

(1) (2R, 3R)                      (2) (2R, 3S)

(3) (2S, 3R)                      (4) (2S, 3S)

Ans. (3)

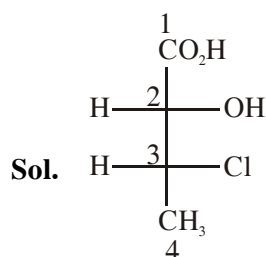

For 2<sup>nd</sup> carbon

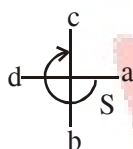

the priority order  $a > b > c > d$

$a = -\text{OH}$

$c = -\text{CO}_2\text{H}$

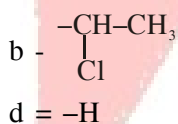

$d = -\text{H}$

For 3<sup>rd</sup> carbon

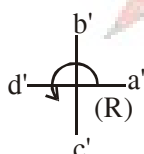

The priority order  $a' > b' > c' > d'$

$a' = -\text{Cl}$

$c' = -\text{CH}_3$

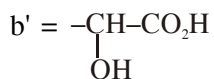

$d' = -\text{H}$